

**NOTES**

PRESTRESSED CONCRETE STRENGTH :  $f'_c = 7,500$  PSI

BUILD-UP CONCRETE STRENGTH :  $f'_c = 7,500$  PSI

STRAND DATA:

SIZE	GRADE	AREA	ULTIMATE STRENGTH	APPLIED PRESTRESS FORCE
0.6"	270 L.R.	0.217	58,600* PER STRAND	43,940* PER STRAND

ALL PRESTRESSING STRANDS SHALL BE 7-WIRE LOW-RELAXATION GRADE 270 STRANDS CONFORMING TO AASHTO M203. STRAND SAMPLING REQUIREMENTS SHALL BE IN ACCORDANCE WITH THE STANDARD SPECIFICATIONS.

THE SLIP-FORM METHOD OF CASTING PILES WILL NOT BE PERMITTED.

TRANSFER THE LOAD FROM THE ANCHORAGES TO THE PILE AFTER THE CONCRETE HAS ATTAINED A MINIMUM COMPRESSIVE STRENGTH OF 4,000 PSI.

IF STRAND STRESS IS RELIEVED BY BURNING, THE STRANDS SHALL BE BURNED IN OPPOSITE PAIRS AS INDICATED IN THE TYPICAL PATTERN SHOWN. FOR ANY NUMBER OF STRANDS, BURN IN OPPOSITE PAIRS AND SYMMETRICALLY ABOUT BOTH THE VERTICAL AND HORIZONTAL AXES. STRANDS 1-1 SHALL BE BURNED BEFORE 2-2, ETC. NOT MORE THAN 4 STRANDS, SAY 5-5 AND 6-6, MAY BE BURNED AT ANY ONE SECTION BEFORE THESE SAME PAIRS OF STRANDS ARE BURNED AT BOTH ENDS OF THE BED AND BETWEEN EACH PAIR OF PILES IN THE BED.

PROPOSED DEVICES FOR LIFTING PILES, RECESS DETAILS, AND PATCHING MATERIAL SHALL BE DETAILED IN SHOP DRAWINGS. AFTER ATTACHMENTS HAVE BEEN REMOVED, OPENINGS SHALL BE REPAIRED SUCH THAT THE APPEARANCE OF THE PILE IS UNIFORM.

WHERE CAST-IN-PLACE LIFTING DEVICES ARE NOT USED, PICK-UP POINTS ARE TO BE INDICATED WITH A 2" WIDE BLACK MARK.

DRIVE PILES USING A METHOD APPROVED BY THE ENGINEER, WHEREBY THE HEAD OF THE PILE IS NOT DAMAGED.

DRIVING OF THE BUILT-UP PILE WILL NOT BE PERMITTED UNTIL THE CONCRETE HAS REACHED A COMPRESSIVE STRENGTH OF 5,000 PSI AND UNTIL A PERIOD OF SEVEN DAYS HAS ELAPSED SINCE CASTING OF THE BUILD-UP.

**DOWEL INSTALLATION FOR OPTIONAL BUILD-UP**

GROUT COMPRESSIVE STRENGTH:  $f'_c = 5,000$  PSI

BEFORE DRILLING DOWEL HOLES, REMOVE THE UPPER 3" OF CONCRETE FROM THE TOP OF THE PILE WITHOUT DAMAGE TO THE REINFORCING STEEL. THE REMOVAL PLANE SHOULD BE NORMAL TO THE EDGE OF THE PILE.

DOWEL HOLES SHALL BE POSITIONED TO MAINTAIN 1/2" CLEAR TO ALL EXISTING PRESTRESSING STRANDS IN THE CONCRETE PILE.

FIELD DRILLED HOLES SHALL BE CLEAN AND FREE OF ANY OBSTRUCTIONS BEFORE GROUTING OF DOWELS. DOWEL BARS SHALL BE INSTALLED AND GROUTED WITH AN APPROVED NON-SHRINK GROUT.

THE SPIRAL REINFORCING IN ALL BUILD-UPS SHALL BE W4.0 COLD DRAWN WIRE WHICH SHALL BE SECURED TO THE LONGITUDINAL REINFORCEMENT TO MAINTAIN PITCH.

THE SPIRAL REINFORCING IN THE BUILD-UP AND THE PRESTRESSED CONCRETE PILE SHALL BE SPLICED BY OVERLAPPING A MIN. OF ONE TURN.

PROJECT NO. \_\_\_\_\_

\_\_\_\_\_ COUNTY

STATION: \_\_\_\_\_

SHEET OF \_\_\_\_\_

STATE OF NORTH CAROLINA  
DEPARTMENT OF TRANSPORTATION  
RALEIGH

STANDARD

20" PRESTRESSED  
CONCRETE PILE

REVISIONS						TOTAL SHEETS
NO.	BY:	DATE:	NO.	BY:	DATE:	
1			3			4
2			4			

DOCUMENT NOT CONSIDERED  
FINAL UNLESS ALL  
SIGNATURES COMPLETED

STD. NO. PCP3

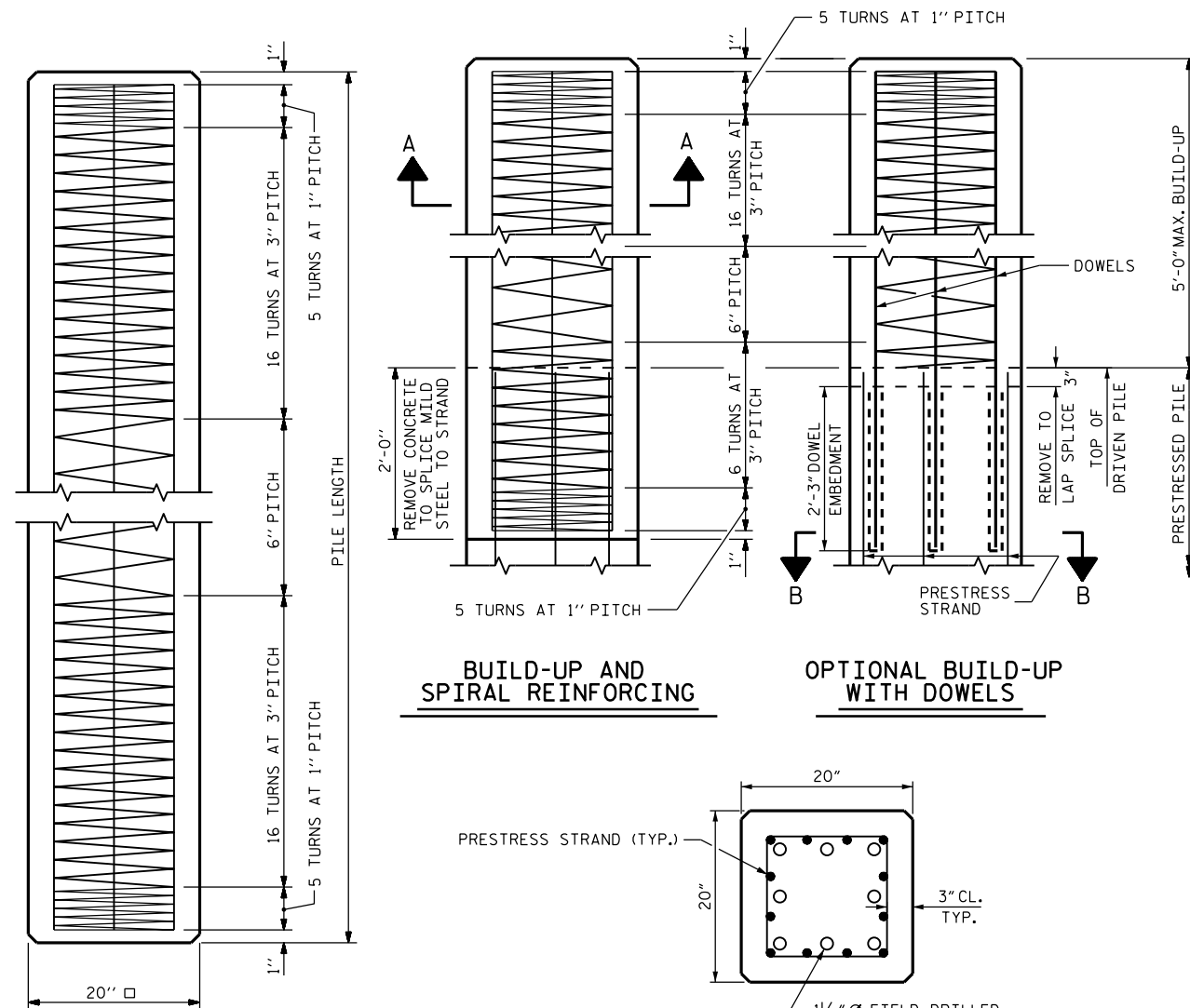

**BUILD-UP AND SPIRAL REINFORCING**

**OPTIONAL BUILD-UP WITH DOWELS**

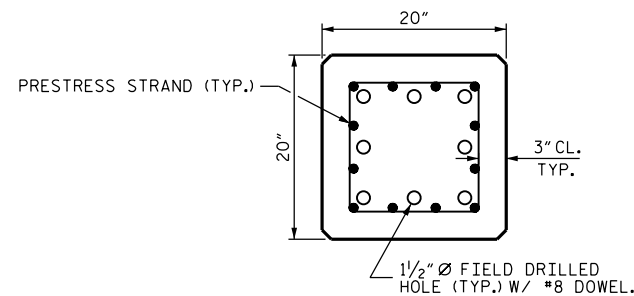

**SECTION "B-B"**

(AT THE CONTRACTOR'S OPTION, PILE BUILD-UP MAY BE CONSTRUCTED WITH DOWELS.)

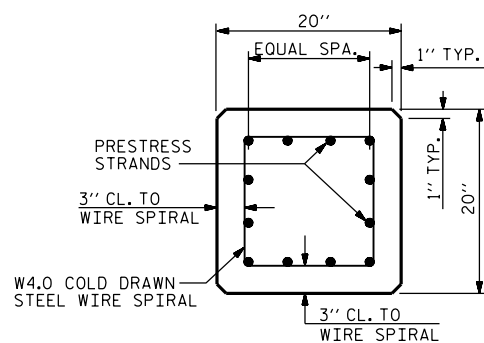

**TYPICAL SECTION**

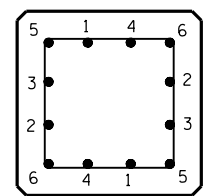

**TYPICAL PATTERN FOR BURNING STRANDS**

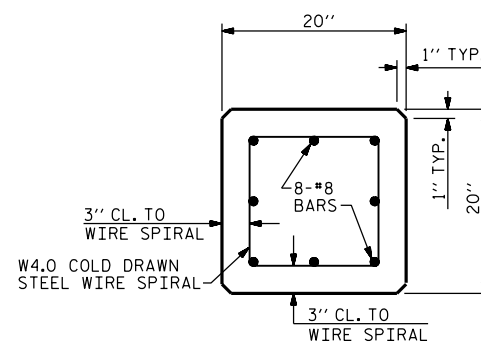

**SECTION A-A**

**0.6" Ø GRADE 270 L.R. PRESTRESS STRANDS**

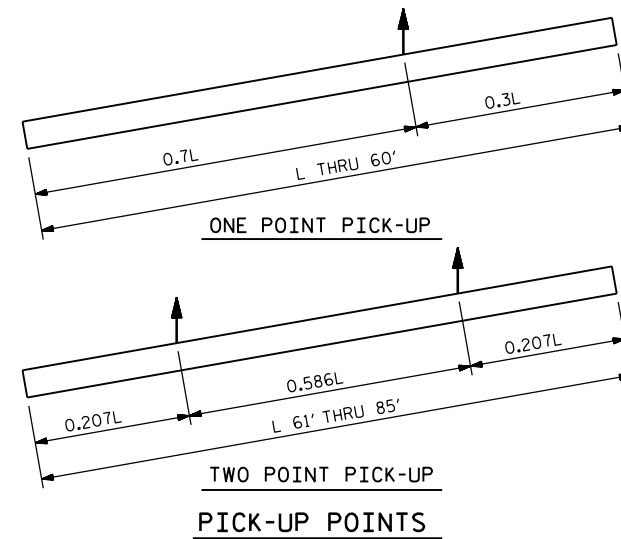

**PICK-UP POINTS**

LENGTH	CONCRETE CU. YDS.	PILE WT. TONS	ONE POINT PICK-UP		TWO POINT PICK-UP	
			0.3L	0.7L	0.207L	0.586L
25'-0"	2.56	5.18	7'-6"	17'-6"		
30'-0"	3.07	6.22	9'-0"	21'-0"		
35'-0"	3.58	7.26	10'-6"	24'-6"		
40'-0"	4.09	8.29	12'-0"	28'-0"		
45'-0"	4.61	9.33	13'-6"	31'-6"		
50'-0"	5.12	10.36	15'-0"	35'-0"		
55'-0"	5.63	11.40	16'-6"	38'-6"		
60'-0"	6.14	12.44	18'-0"	42'-0"		
65'-0"	6.65	13.47			13'-5 1/2"	38'-1"
70'-0"	7.17	14.51			14'-6"	41'-0"
75'-0"	7.68	15.55			15'-6 1/2"	43'-11"
80'-0"	8.19	16.58			16'-6 1/2"	46'-11"
85'-0"	8.70	17.62			17'-7"	49'-10"

**QUANTITIES FOR ONE 20" SQUARE PILE**

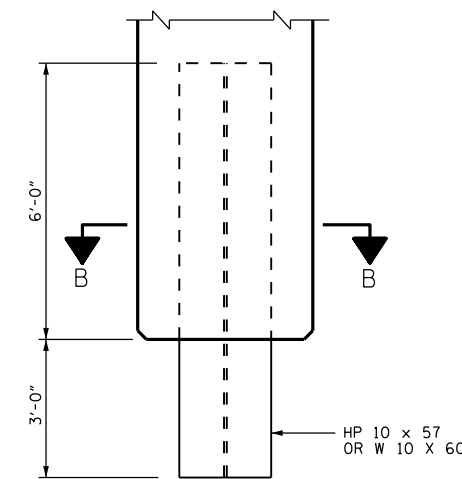

**ELEVATION**

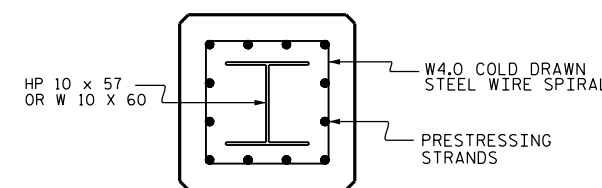

**SECTION B-B  
PILE TIP DETAILS**

FOR 20" SQUARE PRESTRESSED CONCRETE PILE

ASSEMBLED BY :	DATE :
CHECKED BY :	DATE :
DRAWN BY : WJH 1/89	REV. 12/14 MAA/TMG
CHECKED BY : CRK 3/89	REV. 12/17 MAA/THC
	REV. 12/20 BNB/THC